

# OmPlecs®-TOP 200 AMR MF-04 -5- MIMO L1/L2

- Bahnantenne / Train Antenna -



LTE 700 (MIMO) - GSM-R - GSM 1800 - UMTS - LTE 2600 (MIMO) - WLAN 2.4/5.8 (MIMO) - GPS - GLONASS - Galileo - BeiDou

100-58-10-02.52.12

<b>Verwendungszweck</b>	<b>Multiband-Bahnantenne mit Zertifizierung / Zulassung nach Bahnnorm EN 50155 zur Montage auf Schienen- und Kraftfahrzeugen</b>	
<b>Purpose</b>	<b>Multiband-Train Antenna with certification / approval according to train standard EN 50155 for mounting on trains and vehicles</b>	

<b>Technical data / Technische Daten</b>					
RF-Port	a	b	c	d	e
<b>Spectrum</b>	GSM-R / GSM 1800 UMTS / LTE	GSM-R / GSM 1800 UMTS / LTE	WLAN / WiFi-6E	WLAN / WiFi-6E	GPS / GLONASS / Galileo / BeiDou / QZSS
<b>Frequency [MHz]</b>	694 - 960 1710 - 2690	694 - 960 1710 - 2690	2400 - 2500 5180 - 6425	2400 - 2500 5180 - 6425	1164 - 1280 1559 - 1610
<b>Polarization</b>	crosspolar	crosspolar	crosspolar	vertical	right-hand circular
<b>Pattern</b>	omnidirectional	omnidirectional	omnidirectional	omnidirectional	omnidirectional
<b>Gain</b>	7,5 dBi (LTE 700, GSM-R) 8,6 dBi (GSM 1800,UMTS LTE 2600)	7,5 dBi (LTE 700, GSM-R) 8,6 dBi (GSM 1800,UMTS LTE 2600)	9,1 dBi (WLAN 2.4) 10,1 dBi (WLAN 5.8)	9,1 dBi (WLAN 2.4) 10,1 dBi (WLAN 5.8)	Antenna: 9 dBi Amplifier: L1: 35 dB; L2: 37 dB
<b>PCV</b>					PCV: < +/- 4 mm
<b>GDV</b>					1164 – 1280 MHz: 11ns 1559 – 1610 MHz: 8ns
<b>Efficiency</b>	79 %	79 %	89 %	89 %	85 %
<b>VSWR</b>	≤ 1,8 typ.	≤ 1,8 typ.	≤ 1,8 typ.	≤ 1,8 typ.	≤ 1,8 typ.
<b>Impedance</b>	50 Ω	50 Ω	50 Ω	50 Ω	50 Ω
<b>Antenna type</b>	Planar antenna structure	Planar antenna structure	Planar antenna structure	Planar antenna structure	Dual patch antenna
<b>Power / DC Voltage</b>	50 W	50 W	50 W	50 W	-
<b>RF-Connection</b>	N(f)	N(f)	N(f)	N(f)	TNC(f)
<b>Ground-plane</b>	integrated, but min. Ø 300 mm for LTE 700 & GSM 850	integrated, but min. Ø 300 mm for LTE 700 & GSM 850	integrated	integrated	integrated

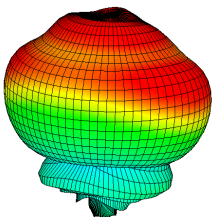
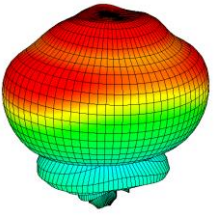
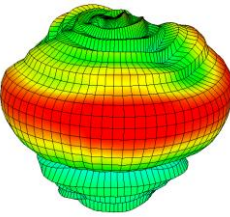
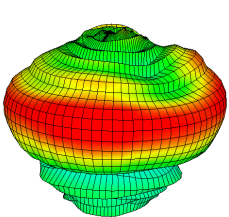
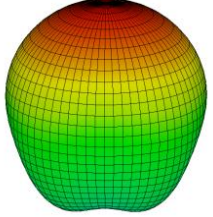
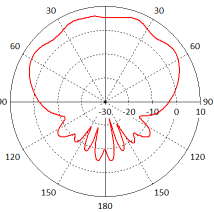
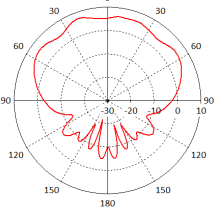
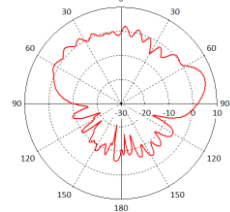
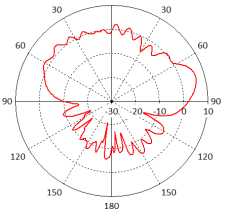
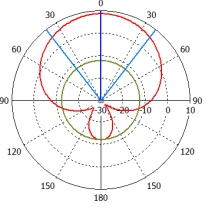
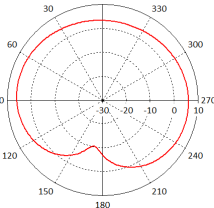
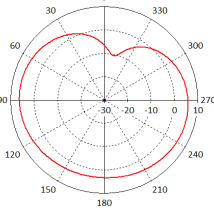
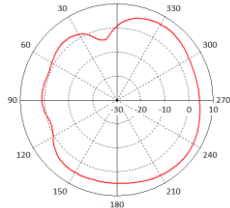
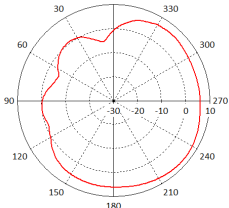
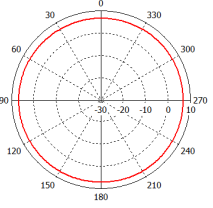
<b>Radiation Diagrams / Richtcharakteristiken</b>					
RF-Port	a	b	c	d	e
<b>3D-Pattern</b>					
<b>2D-Pattern (vertical)</b>					
<b>2D-Pattern (horizontal)</b>					

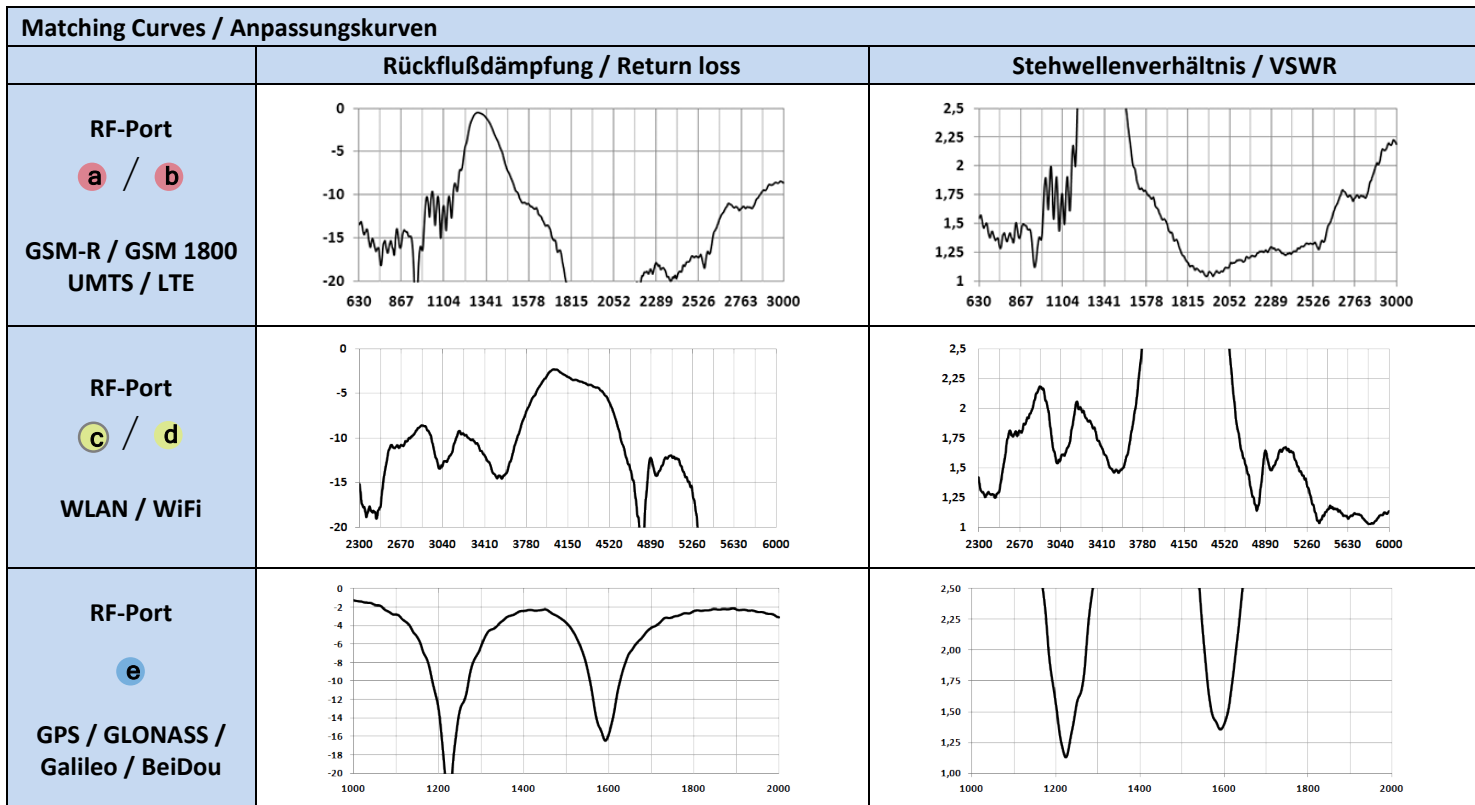

Mechanical Properties / Mechanische Eigenschaften		
Size	Mounting	Color
D: 200 mm H: 60 mm	6 bolts on pitch circle 110 mm, M8 x 40 mm, 60° Torque: 12 Nm	Black or customized (all RAL types)
Weight	Proof of Voltage	Temp. range
ca. 1 500 g	25kV AC / 3kV DC	-60°C to +85°C

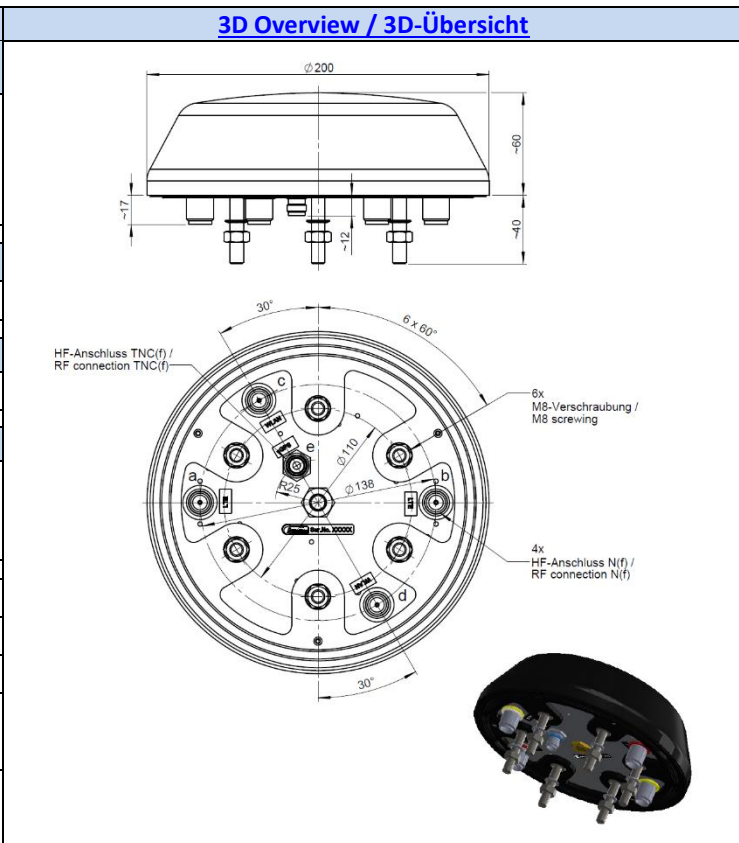

Degree of Protection
Plastic case UV-resistance, waterproof IP6X & IPX9K
Conformity / Konformität
EN 50155, EN 50122-1, EN 50124, IEC 60068, IEC 61373, ISO 20653, ISO 9227, EN 45545-2 2014/30/EU; 2006/28/EC; 2002/95/EC

<b>Drilling pattern</b>	On demand
<b>Drilling template</b>	On demand
<b>Article number</b>	<b>100-58-10-02.52.12</b>
<b>Article number for indoor use</b>	<b>100-58-10-02.52.12-BA</b>
<b>Accessories</b>	<b>Recommend RF-cable: <a href="#">OmProCab-5</a></b>

Amplifier internal					
<b>Frequency [MHz]</b>	for GPS / GLONASS / GALILEO / BeiDou / QZSS	<b>Gain</b>	L1: 35 dB L2: 37 dB	<b>RF-Connection</b>	TNC(f)
<b>Impedance</b>	50 Ω	<b>Noise figure (50 Ω)</b>	L1: 0,95 dB ; L2: 1,05 dB		
<b>Power / DC Voltage</b>	3 V to 5 V at inner conductor	<b>Current</b>	33 mA typ. (3 V) / 38 mA typ. (5 V)		

Es gilt ausschließlich unsere [Montageanleitung](#). \* It applies to our [installation instruction](#) exclusively. \*

ANTONICS GmbH • Ameisenweg 5 • 16727 Velten  
 Telefon +49 3304 25 42 04 • Telefax +49 3304 25 43 48 • HRB 7807NP, Neuruppin  
 Internet: <http://www.antonics.de> • E-Mail: [info@antonics.de](mailto:info@antonics.de)

Die vorstehenden Daten wurden mit Standard-Prüfverfahren an einer Probe aus der Serienproduktion auf einer 1,0 x 1,0 m Massefläche aus Aluminium erstellt. Die Ergebnisse sind daher als allgemeine Anhaltswerte für Materialeigenschaften unter optimalen Bedingungen anzusehen, nicht als Spezifikationsdaten unter davon abweichenden Bedingungen, insbesondere geringerer Masseflächen. Die von Antonics empfohlenen Größen für elektrische Gegengewichte kann der Montageanleitung entnommen werden. Die gemachten Angaben zum Richtdiagramm stellen das typische Abstrahl-/Empfangsverhalten für eine für die Antenne spezifische Frequenz dar. Richtdiagramme weiterer Frequenzen können auf Anfrage zur Verfügung gestellt werden. Sofern nicht ausdrücklich etwas Anderweitiges vereinbart wird, kann keinerlei Garantie für die Eignung des Materials für einen bestimmten Anwendungszweck übernommen werden. Es ist Sache des Käufers, ausreichend zu prüfen, ob sich das Material für seine Zwecke eignet, und das volle Risiko für die Verwendung des Materials zu übernehmen. Trotz aller Sorgfalt bei der Erstellung dieses Dokumentes können sich Daten inzwischen verändert haben. Eine Haftung oder Garantie für die Aktualität, Richtigkeit und Vollständigkeit der zur Verfügung gestellten Informationen kann daher nicht übernommen werden. Des Weiteren behält sich die Antonics GmbH das Recht vor, Änderungen oder Ergänzungen der bereitgestellten Informationen vorzunehmen. Für etwaige Fehler wird keine Haftung übernommen. \*Bei fehlerhafter Montage ist die Gewährleistungspflicht ausgeschlossen. Es gelten ausschließlich unsere [AGB](#), die wir Ihnen auf Anforderung zusenden.

The above data were generated using standard test procedures on a specimen from the series production on a 1.0 x 1.0 m ground plane made from aluminum. The results are therefore regarded as a general reference for material properties under optimal conditions, not as a specification data for alternative conditions, especially smaller ground planes. The recommended dimensions of the ground plane can be taken from the installation instruction. The statements made to the radiation diagram represent the typical radiating / receiving behavior for a specific frequency for the antenna. Radiation patterns of the other frequencies can be provided on request. Unless expressly otherwise agreed, no guarantee regarding the suitability of the material for a particular application can be granted. It is up to the buyer to adequately consider whether the material is suitable for his purposes, and to assume the entire risk of the use of the material. Despite all the care taken in the preparation of this document, some information may have changed. A liability or guarantee for the topicality, correctness and completeness of the information provided cannot therefore be accepted. Furthermore, the Antonics GmbH reserves the right to change or supplement the information provided. No liability is accepted for any errors. \* In case of incorrect mounting, the warranty is excluded. Regarding entirely to Antonics [General Terms and Conditions](#), which we send to you on request.