

Ansicht von oben / top view

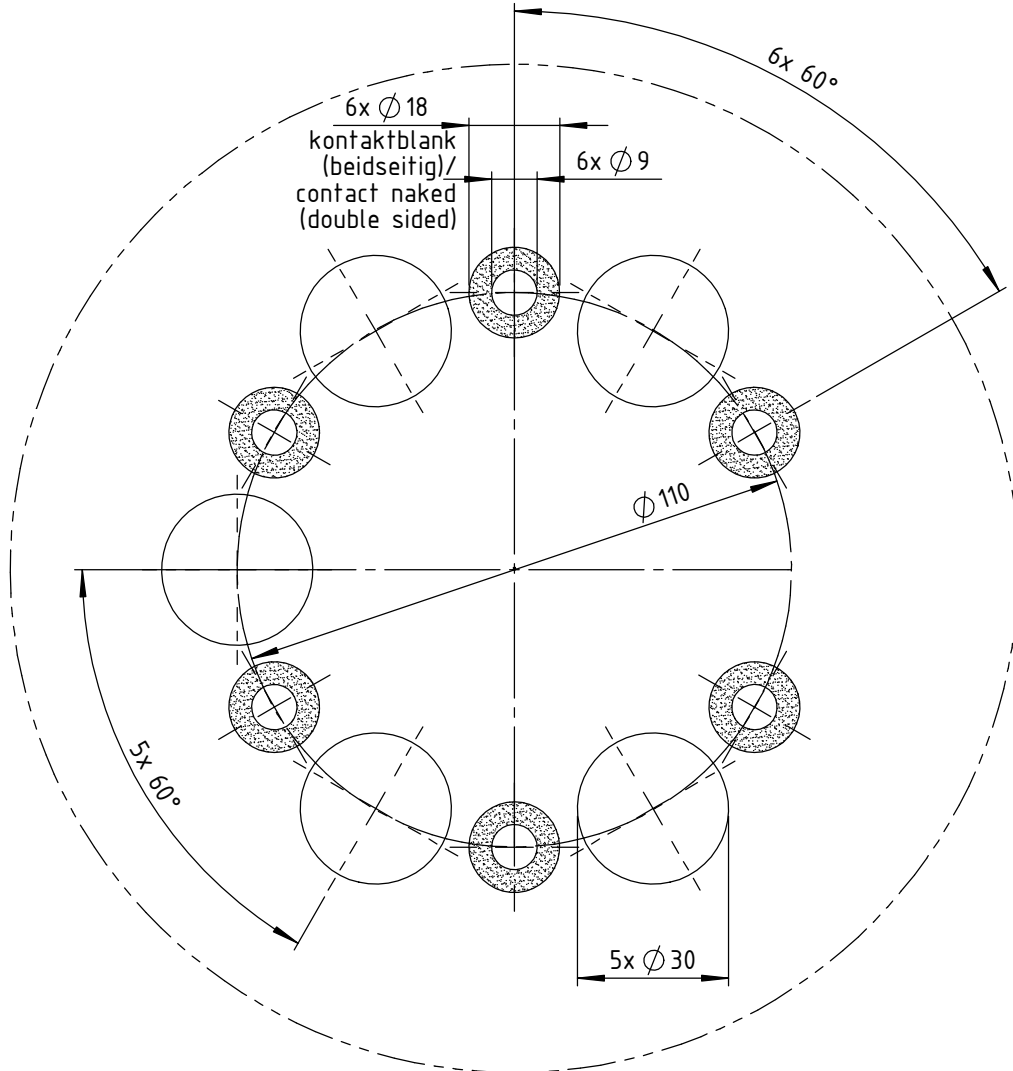

Wenn nicht anders definiert: Bemaßungen in mm Toleranzen:	Oberfläche:	Artikel-Nr.: ---	Maßstab: 1 : 1,5	Gewicht:												
		Werkstoff: ---	Antonics-ICP GmbH http://www.antonics.de													
		<table border="1" style="width: 100%; border-collapse: collapse;"> <thead> <tr> <th style="width: 10%;"></th> <th style="width: 10%;">Datum</th> <th style="width: 10%;">Name</th> </tr> </thead> <tbody> <tr> <td>gezeichnet</td> <td>20.11.2018</td> <td>P. Bojahr</td> </tr> <tr> <td>geprüft</td> <td></td> <td></td> </tr> <tr> <td>genehmigt</td> <td></td> <td></td> </tr> </tbody> </table>		Datum	Name	gezeichnet	20.11.2018	P. Bojahr	geprüft			genehmigt			Benennung: Bohrbild / Drilling pattern Antennenbefestigung / Antenna mounting OmPlecs-TOP 200 AMR MF-06 -5- (100-58-80-05)	
	Datum	Name														
gezeichnet	20.11.2018	P. Bojahr														
geprüft																
genehmigt																
			Zeichnungs-Nr.: BB-200.625	Format: DIN A4 BLATT: 1/1												
<table border="1" style="width: 100%; border-collapse: collapse;"> <thead> <tr> <th style="width: 10%;">Index</th> <th style="width: 10%;">Änderung</th> <th style="width: 10%;">Datum</th> <th style="width: 10%;">Name</th> <th style="width: 10%;">Datei-Nr.:</th> </tr> </thead> <tbody> <tr> <td> </td> <td> </td> <td> </td> <td> </td> <td> </td> </tr> </tbody> </table>	Index	Änderung	Datum	Name	Datei-Nr.:								Ersatz für:			
Index	Änderung	Datum	Name	Datei-Nr.:												

Ameisenweg 5
16727 Veltten/Businesspark
Tel. +49 3304 254204